

Klubmesterskaberne 2002/2003
Seniorafdelingen

Resultater

Klubmesterskaberne er afviklet fra mandag 7. april til og med lørdag 12. april 2003.

Turneringsledelse: SSU I, SSU II og SSU III.

Sven Bo Madsen (44 95 26 90)

Herresingle Mesterrække

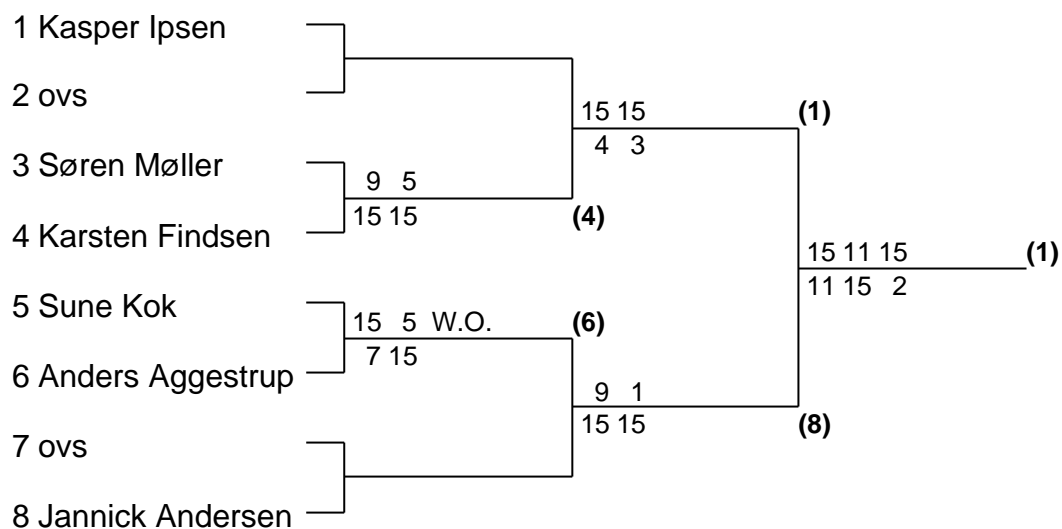

Herredouble Mesterrække

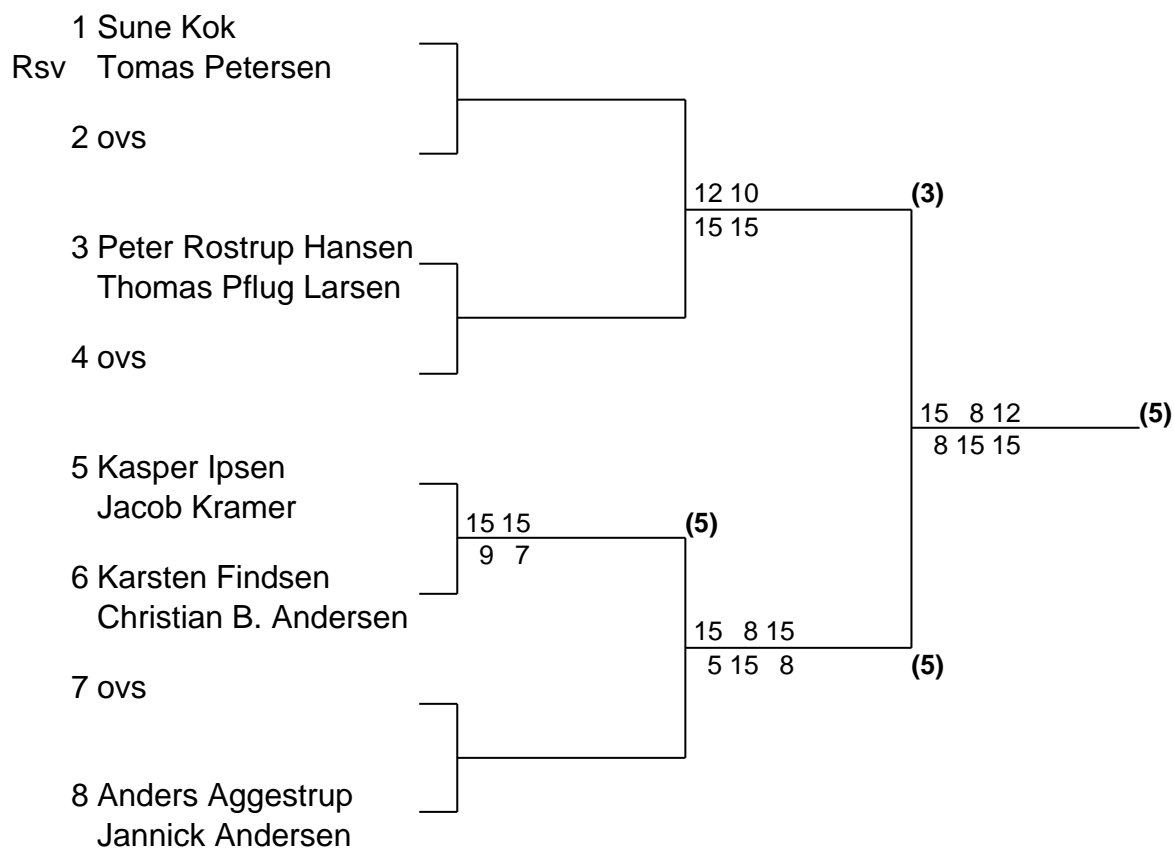

Damesingle Mesterrække

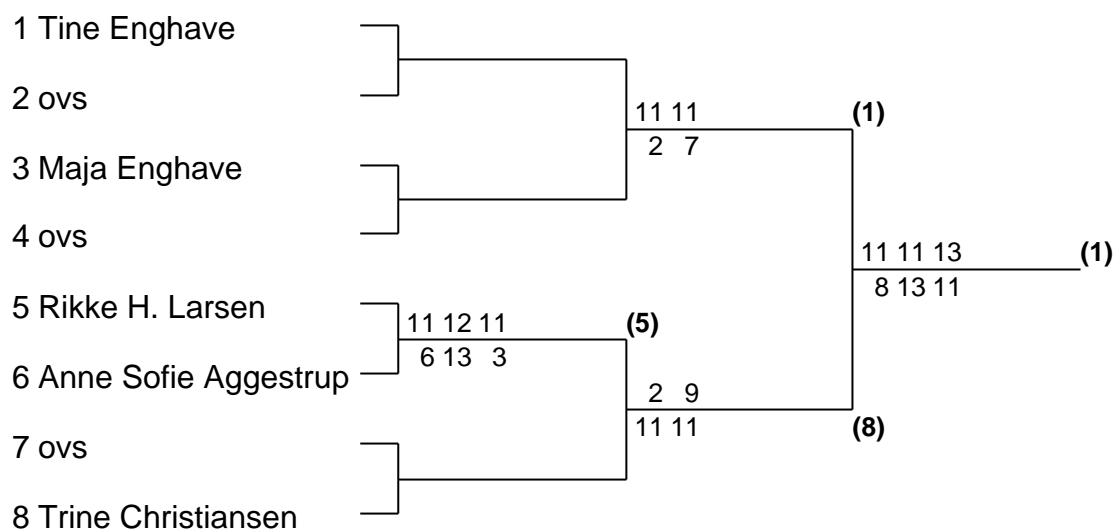

Damedouble Mesterrække

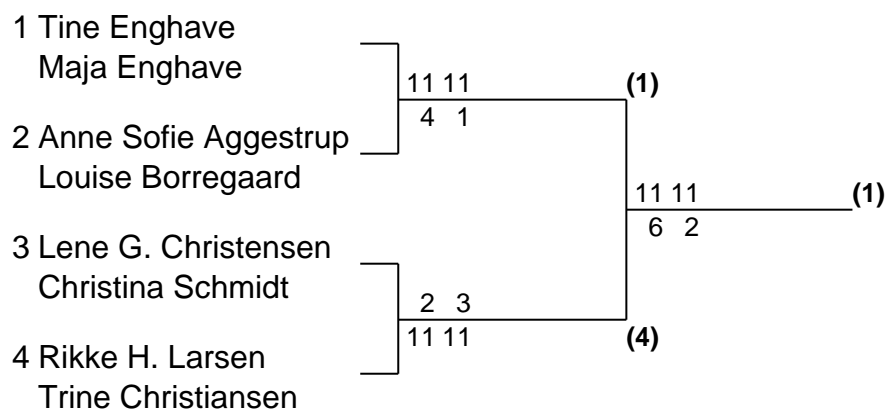

Mixed double Mesterrække

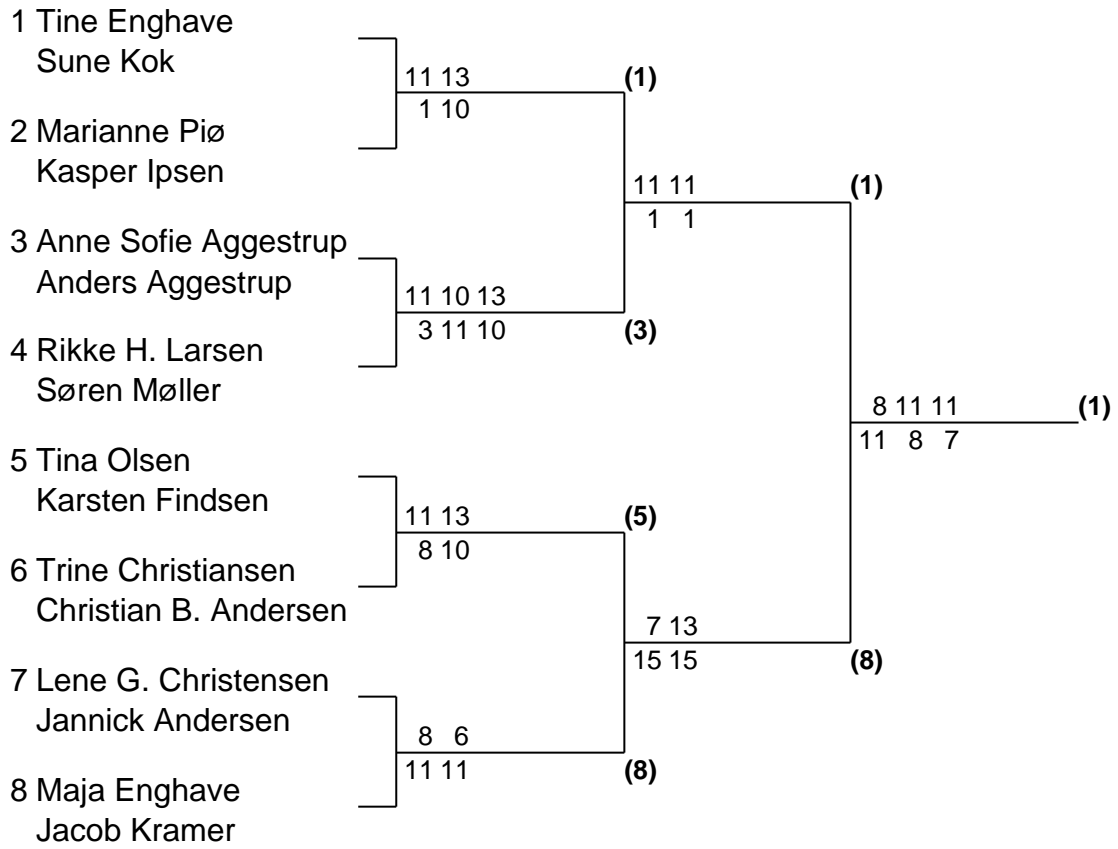

Herresingle Senior-A

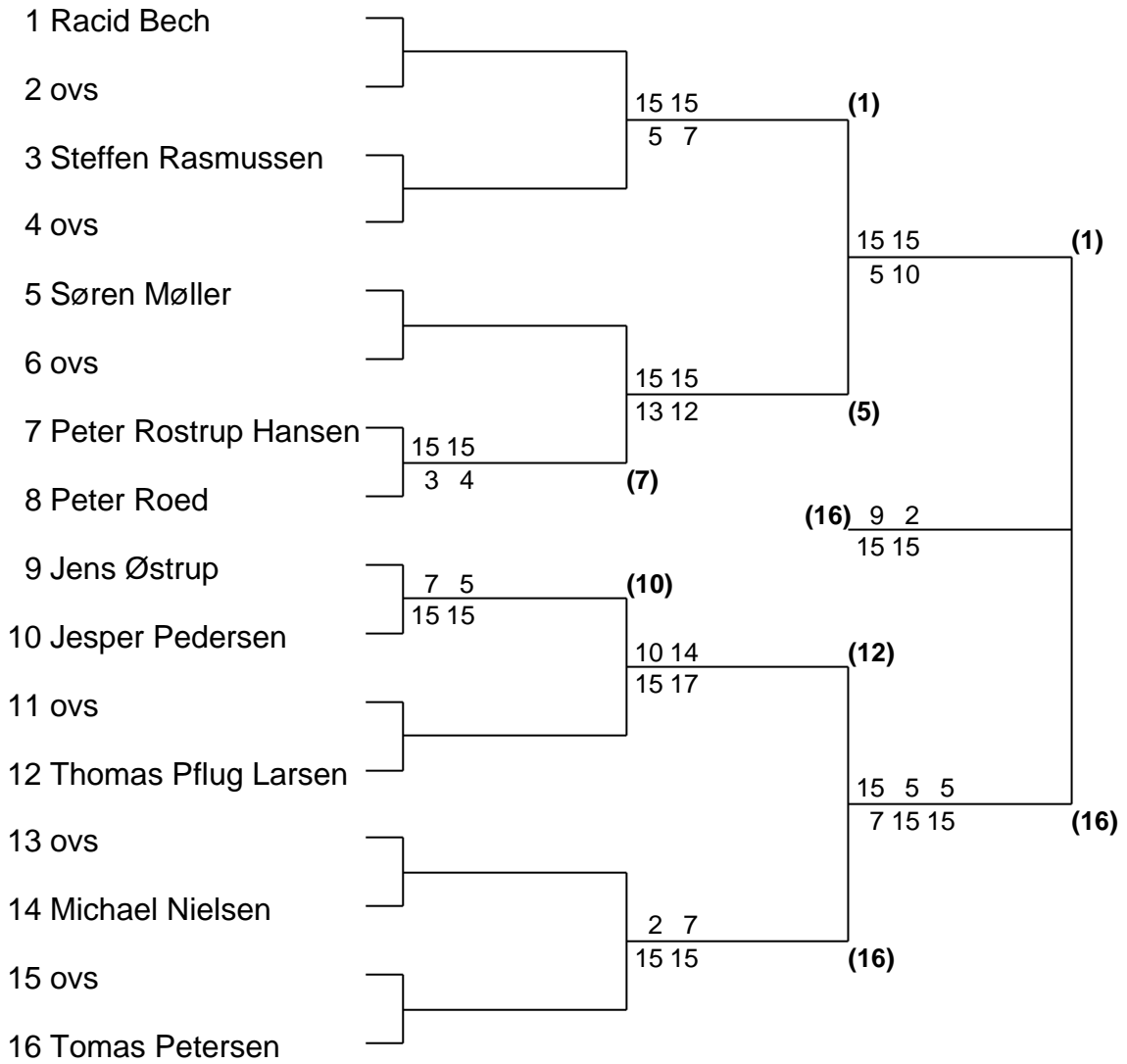

Herredouble Senior-A

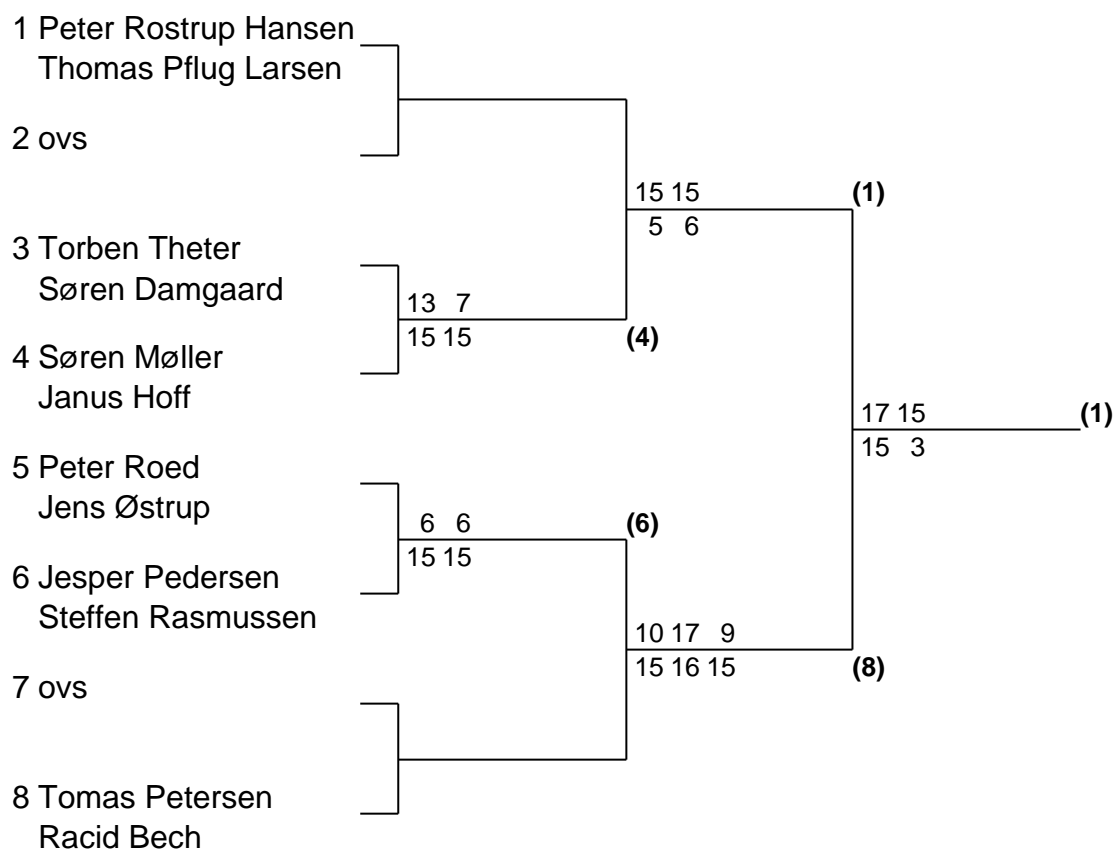

Damesingle Senior-A

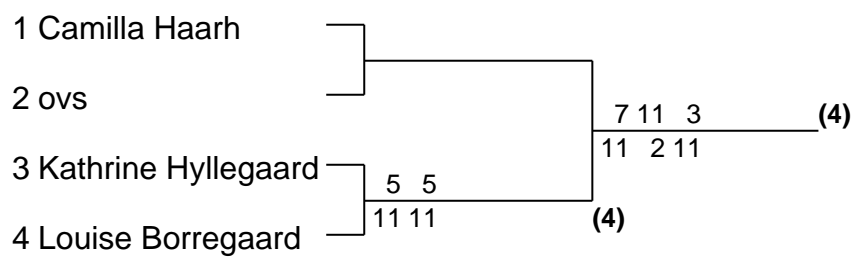

Damedouble Senior-A

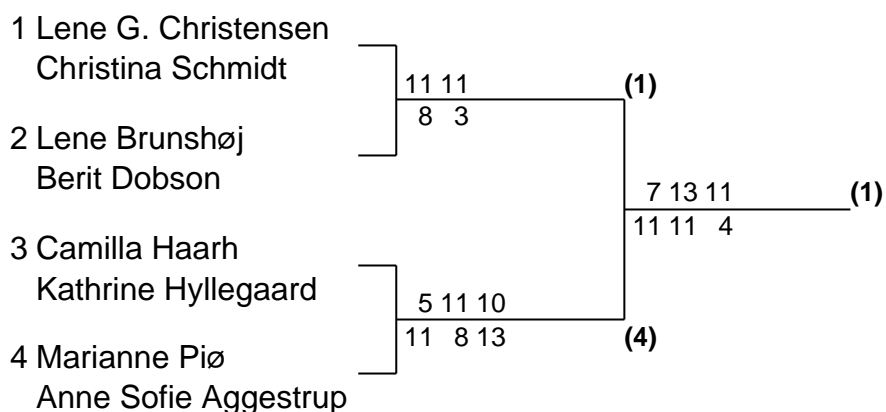

Mixed double Senior-A

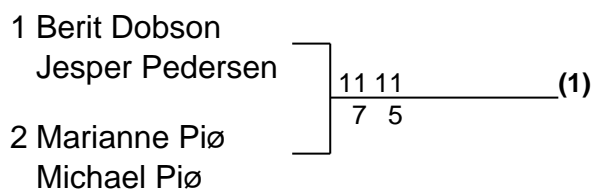

Herresingle Senior-B

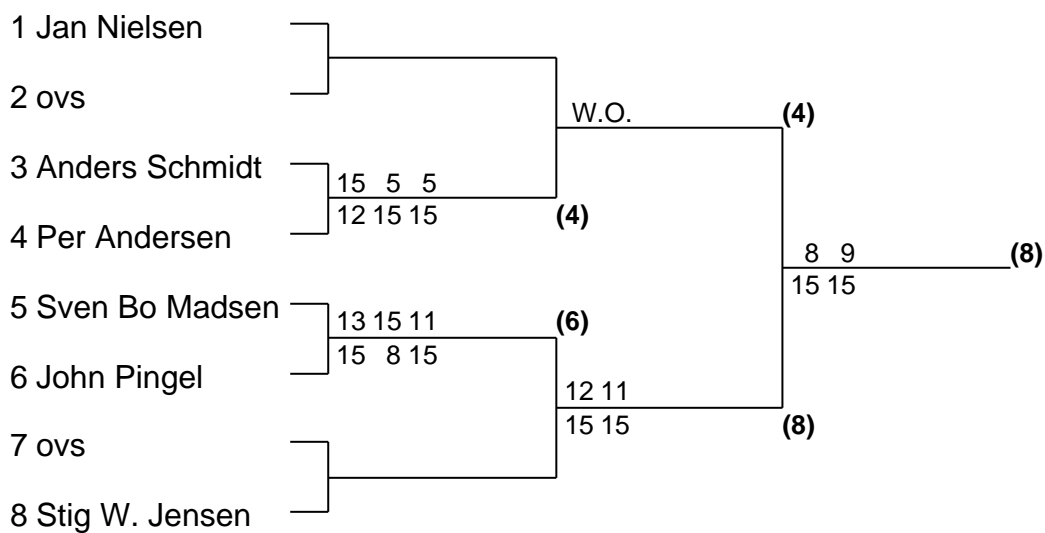

Herredouble Senior-B

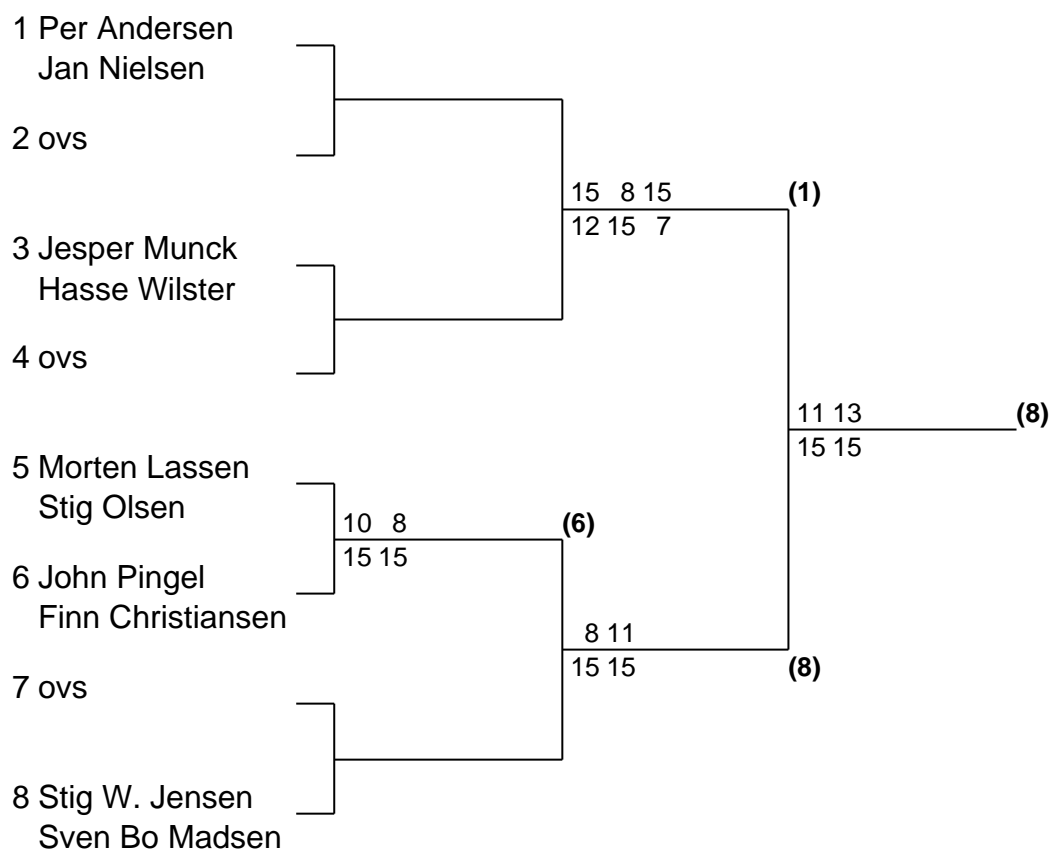

Damedouble Senior-B

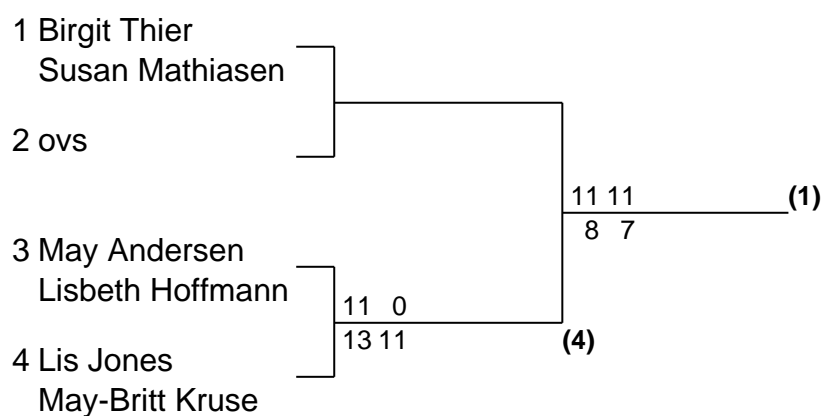

Mixed double Senior-B Pulje 1

1 Pia Schnedler-Meyer John Guldager	2.	1-2 11/9 11/7 (1) 1-3 11/7 11/3 (3) 2-3 W.O. (3)
2 Margot Schmidt Anders Schmidt		
3 Susan Mathiasen Kim Mathiasen	1.	

Mixed double Senior-B Pulje 2

4 Lisbeth Hoffmann Klaus Hoffmann	4.	4-5 11/6 11/4 (5) 6-7 11/6 11/9 (7) 4-6 11/5 11/9 (6)
5 May Andersen Per Andersen	2.	5-7 11/0 11/4 (7) 4-7 11/1 11/2 (7) 5-6 8/11 11/8 11/0 (5)
6 May-Britt Kruse Hasse Wilster	3.	
7 Lis Jones Jesper Munck	1.	

Mixed double Senior-B Puljevinder Finale

3 Susan Mathiasen Kim Mathiasen	}	7 6 11 11	(7)
7 Lis Jones Jesper Munck			

Herresingle Senior-C

1 Steen Jensen	}	15 15 3 1	(1)
2 Bent Harlø			
3 Stig Olsen	}	7 1 15 15	(4)
4 Jacob Hjortkjær			
		15 15 8 6	(1)

Herredouble Senior-C

1 Lars Madsen Steen Jensen	}	15 15	-----	(1)
		4 5		
2 Martin Seindal Michael M. Sørensen	}	15 15	-----	(1)
		8 8		
3 Henning Larsen Jesper Piø	}	6 12	-----	(4)
		15 15		
4 Bent Harlø Jacob Hjortkjær				

Mixed double Senior-C

1 Anita H. Larsen Jesper Piø	}	2 11 1	-----	(2)
		11 5 11		
2 Birgit Piø Henning Larsen				

Herresingle Veteran 40-A Pulje 1

1 Søren Damgaard	1.	1-2 15/1 15/2 (1)
		3-4 14/17 15/7 17/16 (4)
2 Jan Nielsen		1-3 15/2 15/1 (1)
		2-4 15/3 15/2 (4)
3 Stig W. Jensen	3.	1-4 15/2 15/3 (1)
		2-3 W.O. (3)
4 Torben Theter	2.	

Finale spilles mellem nr. 1 og 2 fra puljespillet

1 Søren Damgaard	15	15	
	-----		(1)
4 Torben Theter	4	1	

Herredouble Veteran 40-A

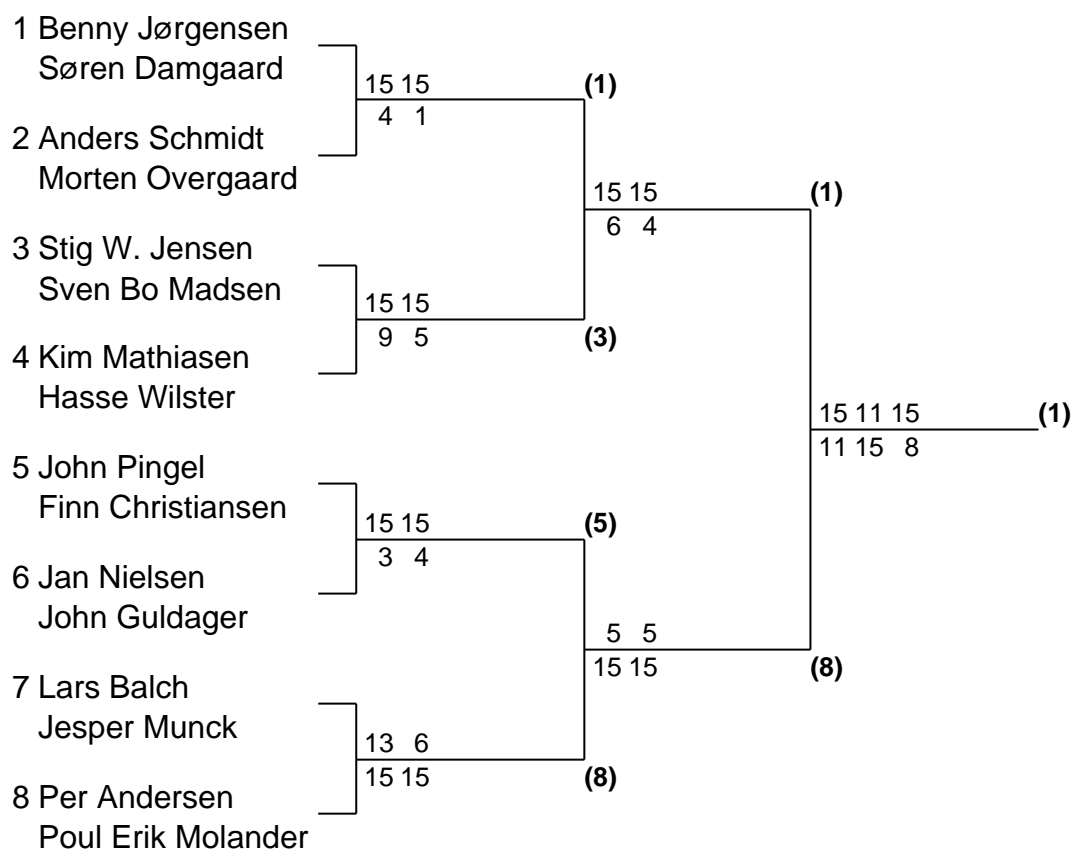

Damedouble Veteran 40-A

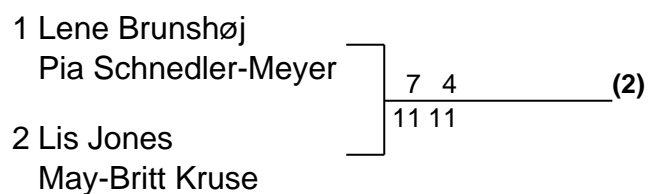

Mixed double Veteran 40-A

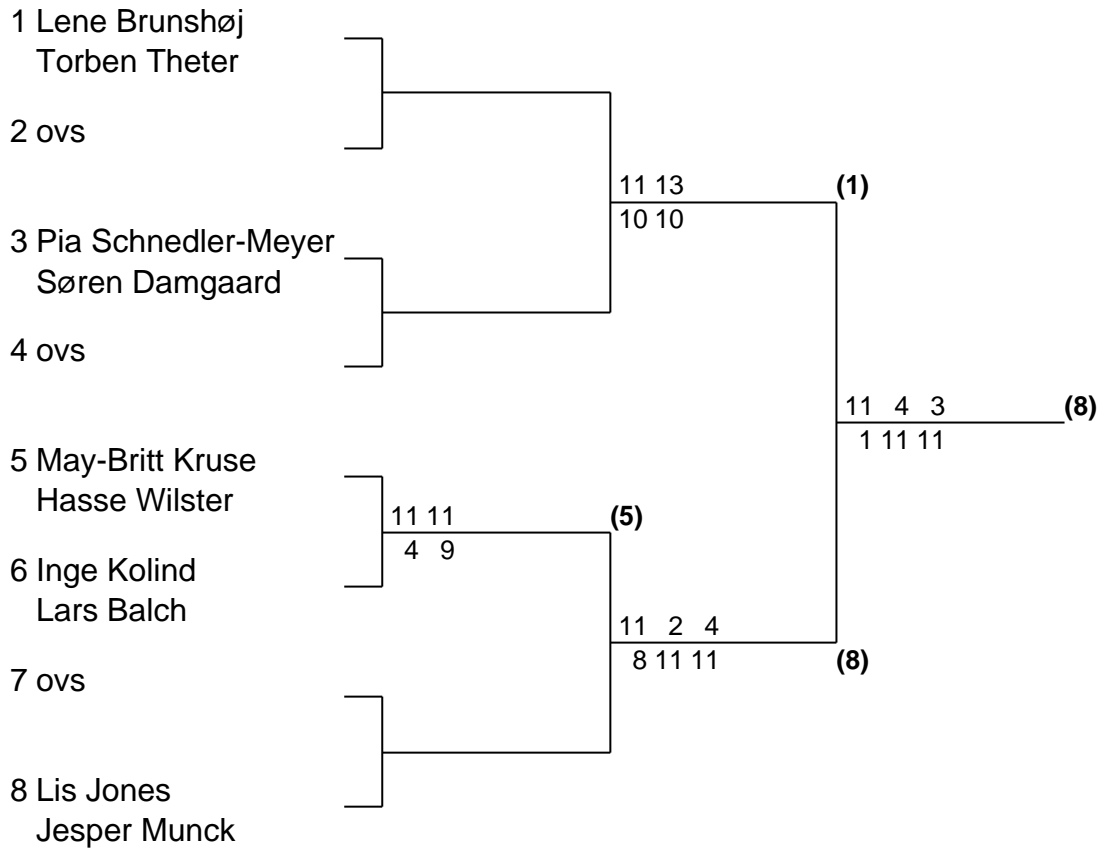

Herredouble Veteran 40-B

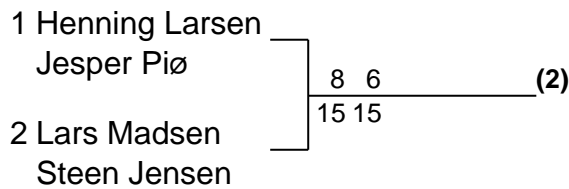

Herredouble Veteran 50-A

